

ENERGIZER 366

SILVER OXIDE

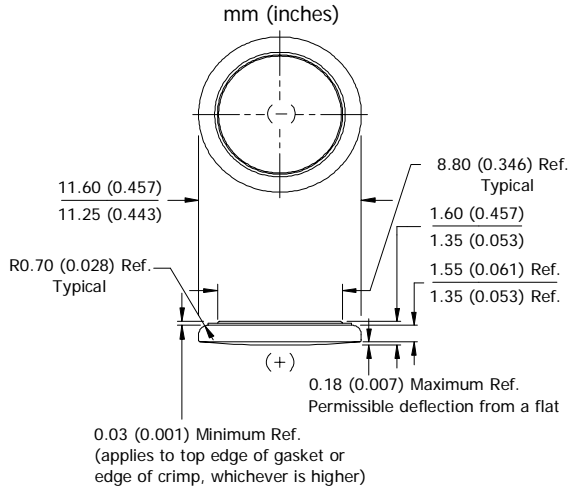

Industry Standard Dimensions



DESIGNED FOR USE ON CONTINUOUS LOW DRAIN

Specifications

Chemical System: Silver Oxide (Zn/Ag₂O)
Designation: ANSI-1177SO
Nominal Voltage: 1.55 Volts
Typical Capacity: 33 mAh* (to 1.3 volts)
Capacity Test: 30K ohm continuous drain at 21°C
Typical Weight: 0.62 grams (0.02 oz.)
Typical Volume: 0.17 cubic centimeters (0.01 cubic inch)
Impedance (40 Hz): 20 to 30 ohms

* Varies according to the applied load, temperature, and cutoff voltage.

Cross Section

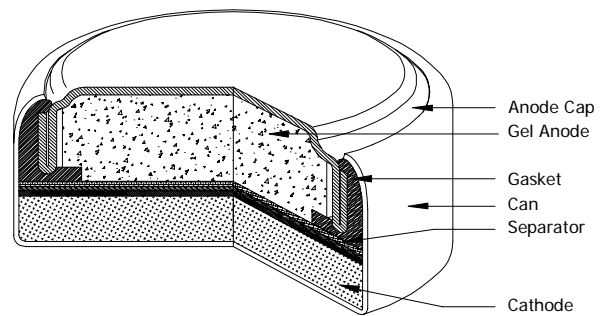

Typical Discharge Characteristics

Typical Performance at 21°C (70°F)

Schedule: Continuous
Typical Drain @1.55V:
 0.052 milliamperes
Load: 30K ohm

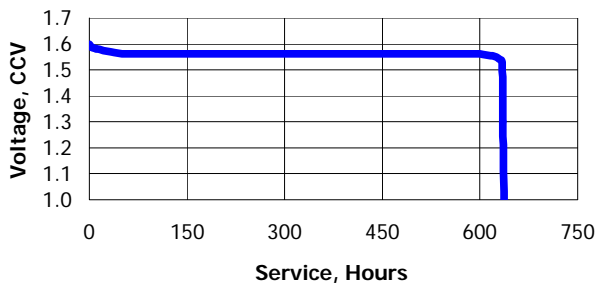

Schedule	Typical Drains at 1.55V (milliamperes)	Load (ohm)	Cutoff (hours)
Continuous	0.052	30K	635

Temperature Characteristics

Typical Performance at Low Discharge Rates

Service Effects

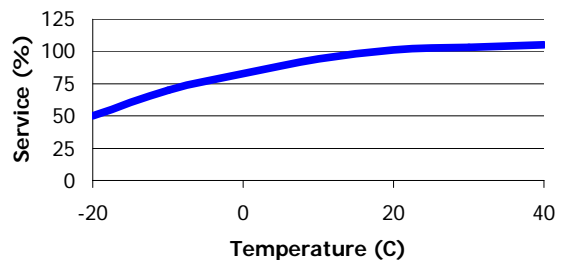

Storage Effects

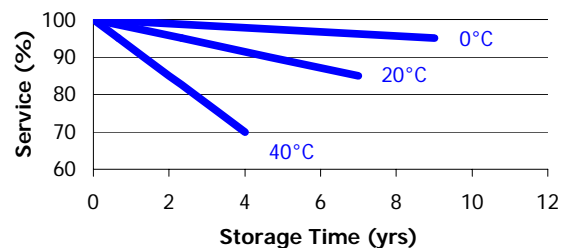

Important Notice

This datasheet contains typical information specific to products manufactured at the time of its publication.

©Energizer Holdings, Inc. - Contents herein do not constitute a warranty.