

GP Batteries

Data Sheet

Model No.: GP180AAHC

Type	Rechargeable Nickel Metal Hydride Cylindrical Cell	
Nominal Dimension (with Sleeve)	Φ =14.5mm H =50.5mm	
Applications	Recommended discharge current 180 to 5400mA	
Nominal Voltage	1.2V	
Capacity	Minimum: 1750mAh Typical: 1800mAh when discharged at 360mA to 1.0V at 20°C	
Charging Condition	180mA for 16 hrs at 20°C	
Fast Charge	900mA to 1800mA (0.5 to 1C) charge termination control recommended control parameters: -ΔV : 0 - 5mV DT/dt : 0.8°C/min (0.5 to 0.9C) : 0.8 - 1°C/min (1C) TCO : 45 - 50°C Timer : 105% nominal input	
Service Life	>500 cycles (IEC standard) Up to 1000 cycles (not less than 60% of nominal at 0.1C charge / 0.2C discharge)	
Continuous Overcharge	180mA maximum current for 1 year No conspicuous deformation and/or leakage	
Weight	26.0g	
Internal Resistance	Average 22mΩ upon fully charged (Range 16-26mΩ) at 1000Hz	
Max. Charging Voltage	1.5V at 180mA charging	
Ambient Temperature Range	Standard Charging	0 to 45°C
	Fast Charging	10 to 45°C
	Discharging	-20 to 50°C
	Storage	-20 to 35°C

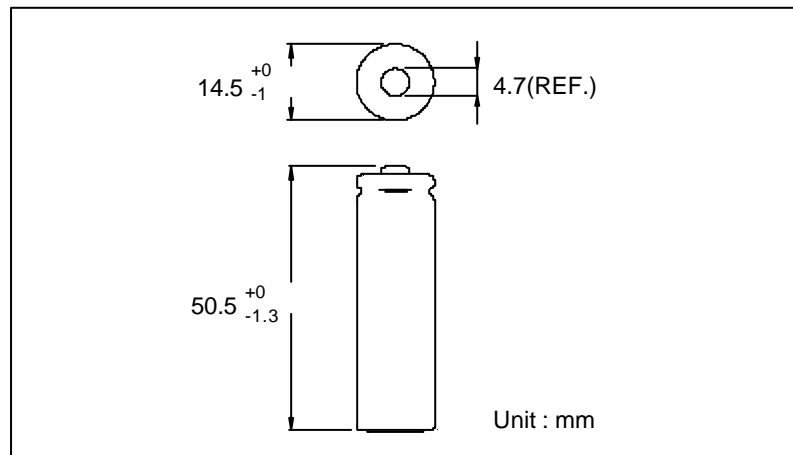

Fast Charge (Charge control required)

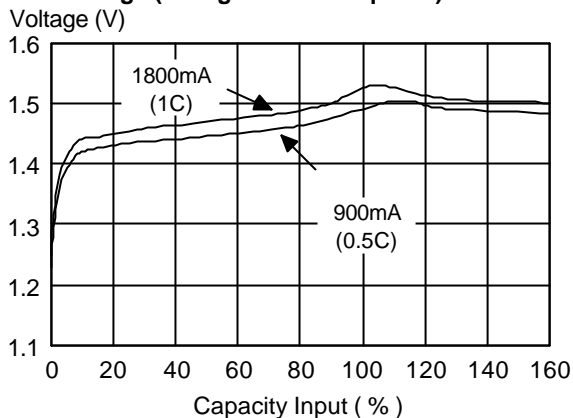

Low Rate Discharge

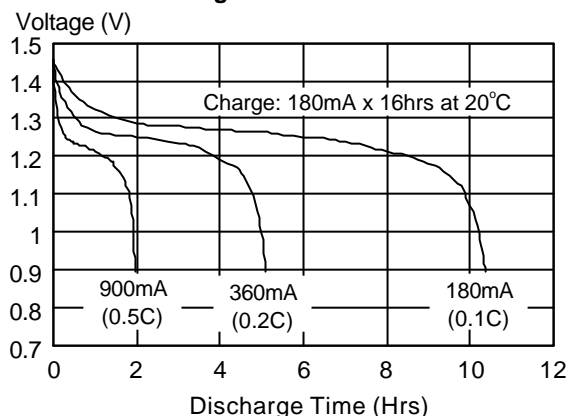

High Rate Discharge

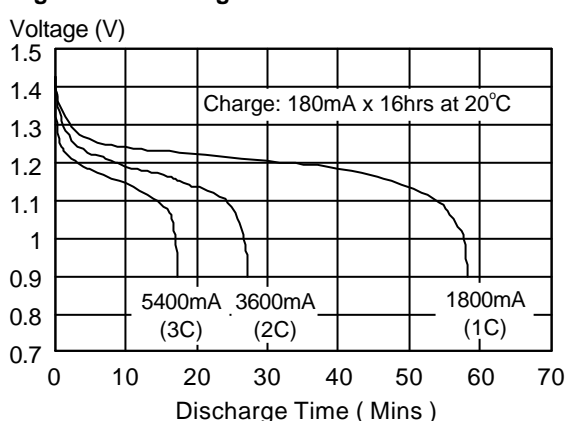

* The information (subject to change without prior notice) contained in this document is for reference only and should not be used as a basis for product guarantee or warranty. For applications other than those described here, please consult your nearest GP Sales and Marketing Office or Distributors.